



CADDY PRODUCTS®

A MOVING IMAGE TECHNOLOGIES COMPANY

CATALOG



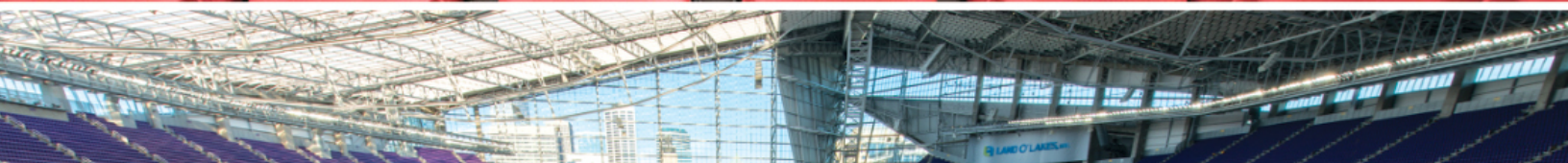

 **CADDY PRODUCTS**[®]
A MOVING IMAGE TECHNOLOGIES COMPANY

TABLE OF CONTENTS

MOTION PICTURE INDUSTRY

PAGE

Caddy Armrest Line	2-4
Caddy CC Armrest Line	4
Caddy Luxury Armrest Line	5
Caddy Recliner Cup Holder	2
Caddy Concession Tray/Table/Tablet Arm Line	8-11

SPORTS INDUSTRY

Caddy I, II, IV, V & VII	13-16
Caddy III	3
Caddy Clamp Line	16
Tel Armrest Line	6-7
Retractable & Telescopic Caddy Line	7
Stadium/Arena Armrest & Arm Cap Line	17
Bleacher Seating Cup Holder Line	18

WORSHIP INDUSTRY

Worship Caddy Line	12
------------------------------	----

PERFORMING ARTS INDUSTRY

Performing Arts Line	19
--------------------------------	----

GROCERY INDUSTRY

Cart Caddy Line	19
---------------------------	----

AIRPORT, NIGHTCLUB, BAR & PORTABLE SANITATION INDUSTRIES

Restroom Caddy Line	20
-------------------------------	----

SPECIALIZED HARDWARE

Attachment Brackets	17
-------------------------------	----

www.CADDYPRODUCTS.com

(800) 845-0591

info@caddyproducts.com

MITQ
(NYSE)



MOVING IMAGE
TECHNOLOGIES

Caddy Armrest Line

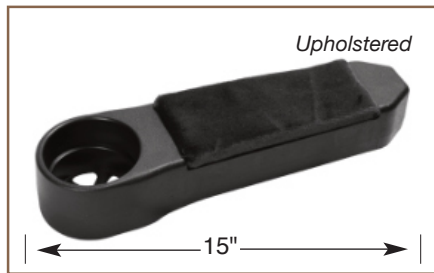

Caddy Regular Length Armrest 2000 Series

Part Number	Description
6008-2000R	Single Step Crossbar
6008-2000RCOV	Plastic Cover
6008-2000RP	Upholstered Plastic Base

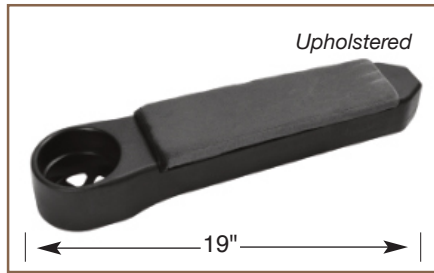
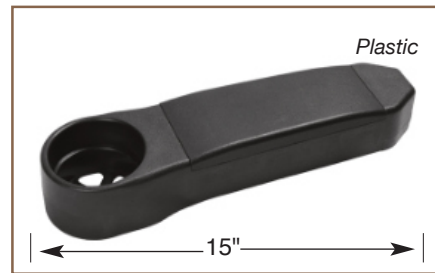

Caddy Extended Length Armrest 2000 Series

Part Number	Description
6008-2000E	Single Step Crossbar
6008-2000ECOV	Plastic Cover
6008-2000EP	Upholstered Plastic Base

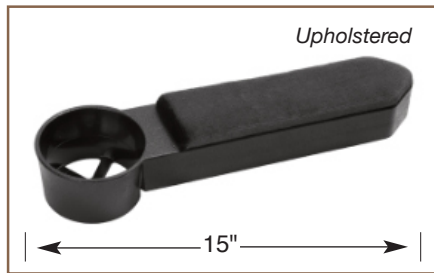
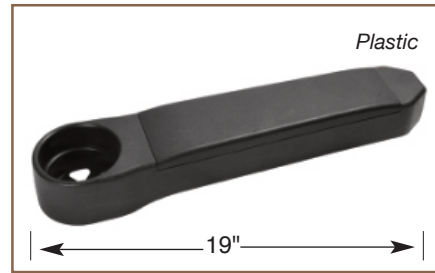

Caddy Regular Length Armrest

Part Number	Description
6008-228	Crossbar Cup
6008-230P	Upholstered Plastic Base
6008-231	Plastic Cover

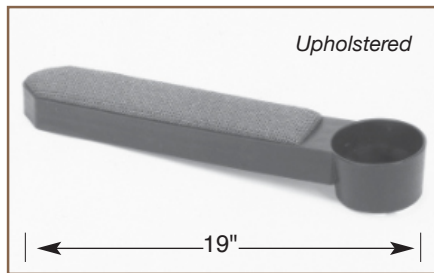
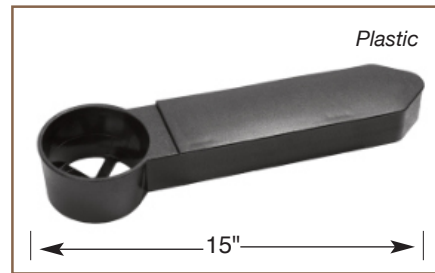

Caddy Extended Length Armrest

Part Number	Description
6008-240	Crossbar Cup
6008-241P	Upholstered Plastic Base
6008-241	Plastic Cover

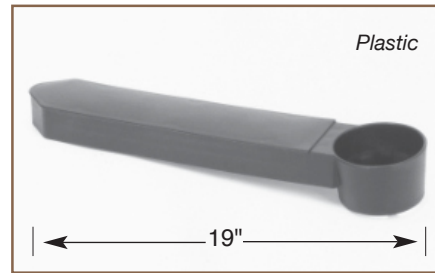

Typical Hardware for All of the Above Products: CCI-105 (2 per unit)
CCI-125 (2 per unit)
Upholstered: add CCI-70 (2 per unit)

Luxury/Recliner Cup Holder



Part Number	Description
6008-100*	Luxury/Recliner Cup Holder (Caddy)
6008-101	Luxury/Recliner Cup Holder (Original)
6008-102**	Luxury/Recliner Cup Holder (No Hole)

Caddy Armrest Line (Cont'd)

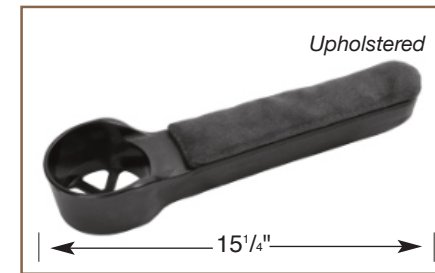

Caddy Slim Fit Armrest

Part Number	Description
Upholstered	
6008-501	Crossbar Cup
6008-502P	Upholstered Plastic Base
Plastic	
6008-500	Crossbar Cup

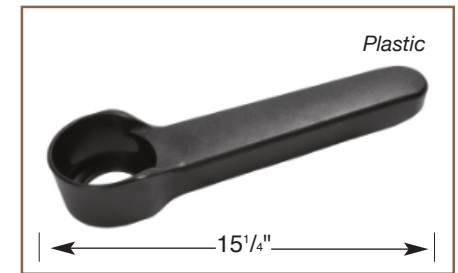

Typical Hardware
CCI-558 (1 per unit)
Upholstered (2 per unit)

Typical Hardware
CCI-558 (1 per unit)
CCI-351 (2 per unit) self-drilling

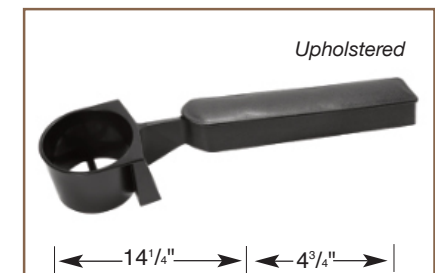

Caddy III Armrest

Part Number	Description
6008-233	Cupholder Base Crossbar
6008-232	Plastic Cover
6008-232P	Upholstered Plastic Base

Typical Hardware
CCI-105 (2 per unit)
CCI-125 (2 per unit)

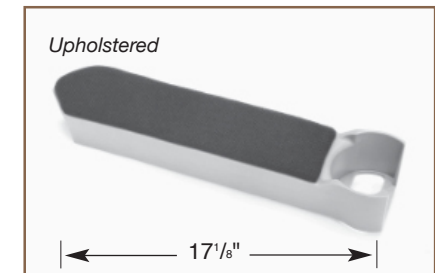
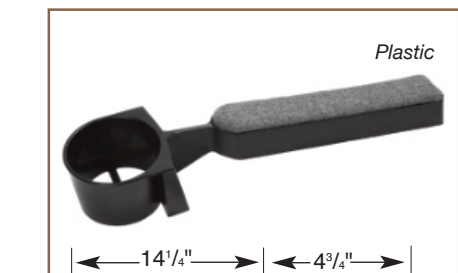

Caddy Loews Armrest

Part Number	Description
6008-245	Cupholder Base Crossbar
6008-246	Plastic Cover
6008-247P	Upholstered Plastic Base

Typical Hardware
CCI-105 (2 per unit)
CCI-125 (2 per unit)

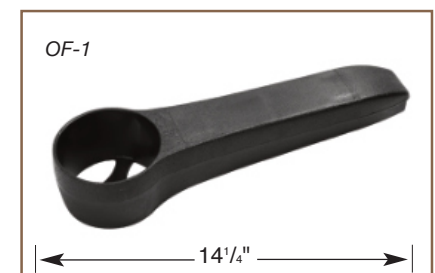
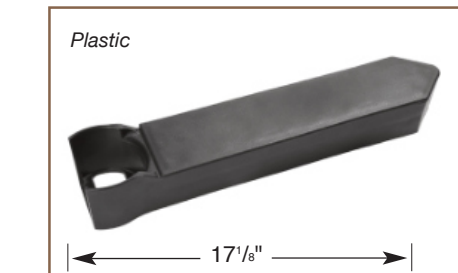

Caddy OF Armrest

Part Number	Description
OF-1	Original Fit Crossbar
OF-11	Original Fit Extended Crossbar
OF-2	Original Fit Vertical Rib Cup

Typical Hardware
CCI-588 (1 per unit)

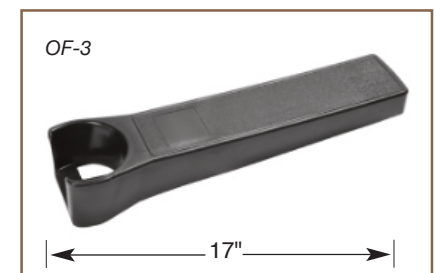
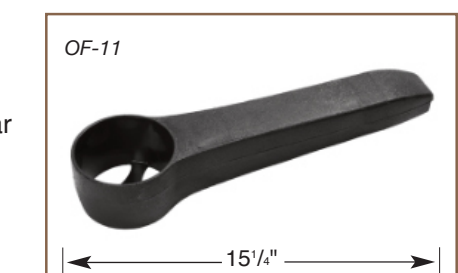

Caddy OF-3 Armrest

Part Number	Description
OF-3*	Original Fit Plastic Crossbar

Cup Inserts

All cup I.D.'s 3 5/8"
Bottom Open Hole I.D.'s (shown)

Typical Hardware
CCI-105 (2 per unit)
CCI-125 (2 per unit)

Caddy Armrest Line (Cont'd)



Caddy 2000 Series Armrest with Number Plates

Part Number	Description
6008-2000RN*	Caddy Regular Armrest Recessed for Number Plates
6008-2000RCOV*	Caddy Regular Armrest Cover Recessed for Number Plates
6008-2000EN	Caddy Extended Armrest Recessed for Number Plates
6008-2000ECOV	Caddy Extended Armrest Cover Recessed for Number Plates



Caddy Quattro Armrest

Part Number	Description
6008-508*	Quattro Armrest Cup Holder Crossbar

Caddy CC Armrest Line



1. CC14

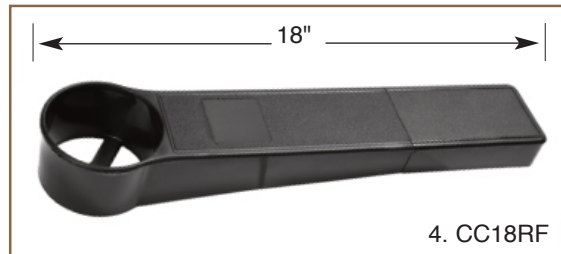

4. CC18RF

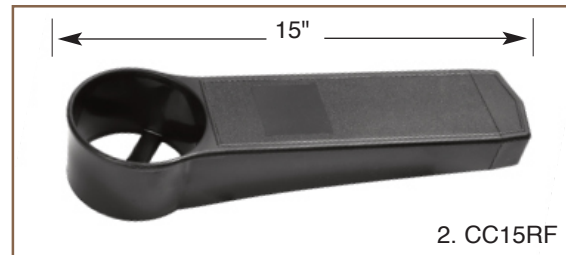

2. CC15RF



5. CC19T

Part Number

1. CC14*	2. CC15	3. CC17	4. CC18	5. CC19T*
CC14 1/2	CC15RF*	CC17RF	CC18RF*	
CC14 1/2RF	CC15RS	CC17RS	CC18T (New)	
CC14 1/2RS		CC17T	CC18T (Old)	
CC14RF				
CC14RS				

Underside

Part Number	Description
1. RS	Rib Slant
2. RF	Rib Flat
3. NR	No Rib



Cup Top I.D.'s
3 3/4"
Cup Bottom I.D.'s
3 1/2"



A. CC Line Crossbar

Note: Caddy CC line products are only produced in Crossbar Bottom cup inserts.

*Items shown.

**Tooling required prior to production of these parts.

Caddy Armrest Line (Cont'd) Caddy Luxury Line

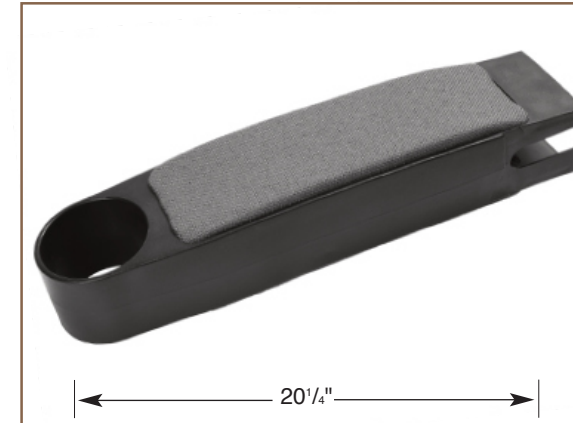

A. Irwin Luxury Vertical Single Step Crossbar
B. Irwin Luxury Crossbar

Irwin Luxury Armrest

Part Number	Description
6008-750*	Irwin Luxury Crossbar
6008-752	Irwin Luxury Vertical Single Step Crossbar
6008-754	Irwin Luxury Single Step Crossbar
6008-772P*	Irwin Luxury Upholstered Plastic Base

Typical Hardware

CCI-351 (1 per unit)

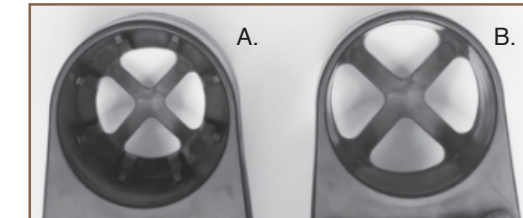

A. Caddy 2000 Luxury Single Step Crossbar
B. Caddy 2000 Luxury Crossbar

Caddy 2000 Luxury Armrest

Part Number	Description
6008-756*	Caddy 2000 Luxury Armrest Cup Holder Crossbar
6008-758	Caddy 2000 Luxury Armrest Cup Holder Single Step Crossbar
6008-762P*	Upholstered Plastic Base

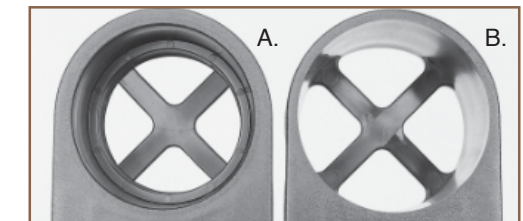

Caddy Luxury Cup 2001

Part Number	Description
6008-2001*	Caddy Luxury Cup 2001



Caddy/Irwin 2005 Luxury Armrest

Part Number	Description
6008-2005*	Luxury Armrest (Main Body)
6008-2005COV	Top Plastic Cover
6008-2005BCOV	Bottom Plastic Cover
6008-2005UCOV	Top Plastic Base for Upholstery
6008-2005UBCOV	Bottom Plastic Base for Upholstery
6008-2005PU	Top Plastic/Bottom Upholstered (3/4" Foam)
6008-2005M	Modified Base

*Items shown.

**Tooling required prior to production of these parts.

Tel Armrest Line



Caddy TEL-1
Part Number
 TEL-1*
Description
 Telescopic Armrest
 Crossbar
 (Slide On)



Caddy TEL-2
Part Number
 TEL-2*
Description
 TEL-2 Armrest
 Open Hole
 (Screw On)



Caddy TEL-3
Part Number
 TEL-3*
Description
 TEL-3 Armrest
 Open Hole
 (Screw On)



Caddy Montel-3
Part Number
 MONTEL-3*
Description
 MONTEL-3 Armrest
 Crossbar (Screw On)



Caddy TEL-4AC
Part Number
 TEL-4AC*
Description
 TEL-4 Arm Cap
 (Screw On)



Caddy TEL-5
Part Number
 TEL-5*
Description
 TEL-5 Armrest
 Open Hole (Screw On)
(Shallow Cup)



Caddy TEL-5X
Part Number
 TEL-5X*
Description
 TEL-5 Armrest
 Crossbar (Screw On)

Caddy TEL-5AC
Part Number
 TEL-5AC*
Description
 TEL-5 Arm Cap
 (Screw On)



Caddy TEL-7
Part Number
 TEL-7*
Description
 TEL-7 Armrest
 Crossbar (Screw On) **(Deep Cup)**



Caddy TEL-8
Part Number
 TEL-8*
Description
 TEL-8 Armrest
 Crossbar (Screw On) **(Deepest Cup)**



Caddy TEL-10
Part Number
 TEL-10
Description
 TEL-10 Armrest
 Crossbar (Slide On)
Part Number
 TEL-10H*
Description
 TEL-10H Armrest, Open Hole (Slide On)



Caddy TEL-10 (Modified)

Part Number
 1. TEL-10TR*
Description
 TEL-10 Track
 Armrest Crossbar
Part Number
 2. TEL-10PAT*
Description
 TEL-10 Patriot Armrest Crossbar
Part Number **Description**
 3. TEL-10A-406* TEL-10 American 406 Armrest Crossbar
Part Number **Description**
 4. TEL-10A* TEL-10 American 505 Armrest Crossbar



Caddy TEL-20
Part Number
 TEL-20*
Description
 TEL-20 Armrest Crossbar
 (Screw On)



Part Number **Description**
 TEL-20H TEL-20H Armrest, Open Hole (Screw On)
Typical Hardware
 CCI-588 (Slide On) & No Hardware for Screw On

Secondary Operational undercuts vary for each part.
 *Items shown.
 **Tooling required prior to production of these parts.

Tel Armrest Line (Cont'd)



Caddy TEL-21
Part Number
 TEL-21*
Description
 TEL-21 Armrest
 Open-Hole (Screw On)

Caddy TEL-22
Part Number
 TEL-22*
Description
 TEL-22 Armrest
 Crossbar (Screw On)



Retractable & Telescopic Caddy Line

Retractable Caddy



Part Number	Description
2" DEPTH	
6008-570L	Caddy/Integra Retractable Shallow Cup, Bracket & Dowel-2" LEFT
6008-570R*	Caddy/Integra Retractable Shallow Cup, Bracket & Dowel-2" RIGHT
6008-570U	Caddy Retractable Shallow Cup, Bracket & Dowel-2" UNIVERSAL
Typical Hardware	
CCI-120	(2 per unit)



Part Number	Description
2.5" DEPTH	
6008-575L*	Caddy/Integra Retractable Deep Cup, Bracket & Dowel-2.5" LEFT
6008-575R	Caddy/Integra Retractable Deep Cup, Bracket & Dowel-2.5" RIGHT
6008-575U	Caddy Retractable Deep Cup, Bracket & Dowel-2.5" UNIVERSAL
Typical Hardware	
CCI-120	(2 per unit)

Telescopic Caddy



Part Number	Description
2" DEPTH	
6008-580L*	Caddy/Integra Telescopic Cup, Bracket & Dowel-2" LEFT
6008-580R	Caddy/Integra Telescopic Cup, Bracket & Dowel-2" RIGHT
6008-580U	Caddy Telescopic Cup, Bracket & Dowel-2" UNIVERSAL
Typical Hardware	
CCI-120	(2 per unit)

*Items shown.
 **Tooling required prior to production of these parts.

CADDY RECLINER TRAYS I & II

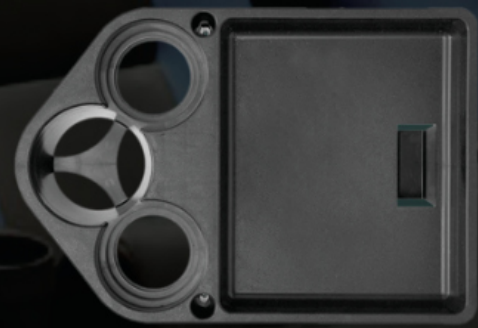

CADDY RECLINER TABLES III & IV



Custom inserts to securely fit all recliner cup holders.
Available in any color.



- Effective swivel table solution for recliner seating
- Portable, not permanently mounted
- Eliminate recurring costs of disposable trays
- Promotes even larger concessions sales
- Reusable and cost effective
- A fraction of the cost of permanently mounted table
- Reduces clean-up time

MOBILE
STORAGE
STAND



Caddy Concession Tray, Table and Tablet Arm Line



Caddy Concession Tray I

Part Number
TRAY I Inserts:
A, B, C, D, E, F, G, H, I, J, K,
L, M, N, O
*Note: Custom inserts to fit
various cup holder models.*

Description Concession Tray I

LxW 14½x10



Caddy Concession Tray II

Part Number
TRAY II Inserts:
A, B, C, D, E, F, G, H, I, J, K,
L, M, N, O
*Note: Custom inserts to fit
various cup holder models.*

Description Concession Tray II

LxW 17½x11⅞/16



Caddy Concession Table III

Part Number
TABLE Riser Heights & Inserts
225: B, D
325: A
425: A, B, C, D, E, F, G, H
*Note: Custom inserts to fit various
cup holder models.*

Description Table III (Large)

LxW 21x14



Caddy Concession Table IV

Part Number
TABLE Riser Heights & Inserts
225: B, D
325: A
425: A, B, C, D, E, F, G, H
*Note: Custom inserts to fit various
cup holder models.*

Description Table IV (Small)

LxW 19x11

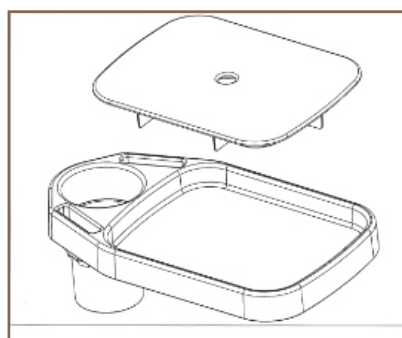

Caddy Concession Table Conversion Top

Part Number
Conversion Top**
Description Concession Table
Conversion Top

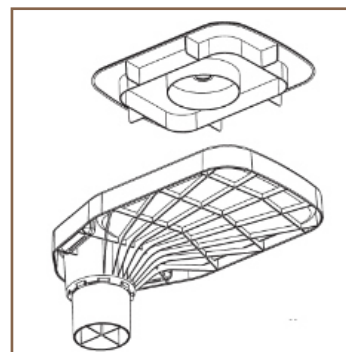

**Items shown.*

***Tooling required prior to production of these parts.*

Caddy Concession Tray, Table and Tablet Arm Line (Cont'd)



Caddy Tablet Arm

Part Number
Tablet Arm Inserts: A, B, D, H
**C, E, F, G, I, K, L, M, N, O
Description Tablet Arm

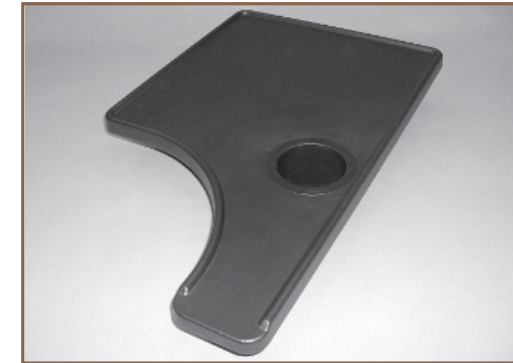

US Tray Stand

Part Number	Description
US Stand*	US Concession Tray Stand (original) For Tray I & II

*Note: Concession tray stands include
wheels and handle for easy mobility.*



**Items shown.*

***Tooling required prior to production of these parts.*

Worship Caddy Line



Worship Caddy I

- 2 Envelope/Card Holders or 1 Large Pamphlet Holder
- 2 Pen/Pencil Holders
- Book Compartment
- Available with:
0, 2 or 4 Communion Cup Holders
- Your Message or Symbol is Molded into the Plastic (Optional)
- Available in Wing Plate Mount or Pew Mount

Worship Caddy I

Part Number	Description
6008-800*	CIT Model
6008-801	MAR Model
6008-802	MIL Model
6008-803	PEW Model
6008-804	CON Model
6008-805	QTO Model

Typical Hardware
TS 1 1/4 B.D. (4 per unit)



Worship Caddy II

- 2 Envelope/Card Holders or 1 Large Pamphlet Holder
- 2 Pen/Pencil Holders
- 2 Optional Communion Cup Holders
- Your Message or Symbol is Molded into the Plastic (Optional)
- Mounts Directly to Seat Back

Worship Caddy II

Part Number	Description
6008-820*	Pew Mount
6008-821	Contoured Seat Mount
6008-822	Marquee

Typical Hardware
TS 1 1/4 B.D. (4 per unit)



Worship Caddy III

- 2 Envelope/Card Holders or 1 Large Pamphlet Holder
- 2 Pen/Pencil Holders
- Book Compartment
- Available with:
0, 2 or 4 Communion Cup Holders
- Your Message or Symbol is Molded into the Plastic (Optional)
- Mounts Directly to Seat Back

Worship Caddy III

Part Number	Description
6008-830*	Contoured Seat Mount

Typical Hardware
CCI-1081 (4 per unit)



End of Row Bulletin Caddy

- Available with 1 Large Bulletin Holder to Mount on End of Pew

Bulletin Caddy

Part Number	Description
6008-840*	Bulletin Holder Caddy

Typical Hardware
TS 1 1/4 B.D. (4 per unit)



Wing Plate Mount for Chairs
Worship Caddy I



Contoured Seat Mount
Worship Caddy II



Flat Mount for Pews
Worship Caddy II



Contoured Seat Mount
Worship Caddy III



Bulletin Caddy

Note: All Worship Caddy products will be produced with communion cups unless specified otherwise.

*Items shown.

**Tooling required prior to production of these parts.

Caddy I, II, IV, V & VII Custom Lines



Caddy I

Part Number	Description
6008-125*	Model 1

Multiple Applications

Typical Hardware

CCI-120 (4 per unit)
Concrete: CCI-570 (4 per unit)



Caddy II Multiple Applications

Part Number	Description
6008-150*	II A Irwin/Hussey/Massey
6008-175*	II B American
6008-200*	II C Seating Concepts

Typical Hardware
CCI-120 (1 per unit)
CCI-423 (1 per unit)



Euro Caddy I

Part Number	Description
6008-258*	Euro Caddy I-A
6008-259	Euro Caddy I-B
6008-260	Euro Caddy I-C



Euro Caddy II

Part Number	Description
6008-250*	Euro Caddy II
6008-251	Snap On Cup Only

Typical Hardware
CCI-105 (2 per unit)
CCI-120 (2 per unit)



Irwin

Part Number	Description
6008-265*	Caddy IV Irwin

Typical Hardware **if required*

CAD-4-2 (4 per unit)
CAD-4A (4 per unit)



Hussey

Part Number	Description
6008-267* 6"	Caddy IV
	Hussey Regular
6008-299 5 1/2"	Caddy IV
	Hussey Upper Mount

Typical Hardware **if required*
SSN 18-9 (4 per unit)



American 406

Part Number	Description
6008-265*	Caddy IV
	American 406

Typical Hardware **if required*

CAD-4-2 (4 per unit)
CAD-4A (4 per unit)



American 505

Part Number	Description
6008-268*	Caddy IV
	American 505

Typical Hardware **if required*
CAD-4-2 (4 per unit)
CAD-4A (4 per unit)



Track

Part Number	Description
6008-263*	Caddy IV Track



Track

Part Number	Description
6008-300*	Caddy IV Track
	Upper Mount



Interkal

Part Number	Description
6008-351*	Caddy IV Interkal



End of Row/VRC

Part Number	Description
6008-280*	American 505 R 5"
6008-281	American 505 L 5"
6008-310	Hussey R 6"
6008-320	Hussey L 6"
6008-330	Hussey Upper R 5 1/2"
6008-340	Hussey Upper L 5 1/2"
6008-377	Camatic R 5 1/8"
6008-376	Camatic L 5 1/8"
6008-386	Track Lower L 9"
6008-387	Track Lower R 9"

Measurements reflect bracket length from center of hole to center of hole.

*Items shown. **Tooling required prior to production of these parts.

Caddy I, II, IV, V & VII Custom Lines (Cont'd)



Caddy IV End of Row Lower and Upper American and Irwin

Part Number	Description
6008-380	Caddy IV End of Row Lower Right Model
6008-381*	Caddy IV End of Row Lower Left Model
6008-384*	Caddy IV End of Row Upper Right Model
6008-385	Caddy IV End of Row Upper Left Model



Caddy IV Medallion End of Row

Part Number	Description
6008-274	Caddy IV Medallion End of Row Cup Holder-Right
6008-275	Caddy IV Medallion End of Row Bracket - Right
6008-276*	Caddy IV Medallion End of Row Cup Holder-Left
6008-277*	Caddy IV Medallion End of Row Bracket - Left

Caddy IV & V Medallion

Part Number	Description
6008-278*	Caddy IV Custom Medallion Cup Holder
6008-605HP*	Caddy V Custom Medallion Cup Holder
6008-279*	Custom Medallion Bracket



Caddy IV Front Row/ADA

Part Number	Description
6008-278*	Caddy IV Front Row/ADA Cup Holder
6008-350*	Front Row/ADA Bracket



Caddy V Front Row/ADA

Part Number	Description
6008-611 HP*	Caddy V Rail Mount w/Pen Holder and Binocular Post



Part Number	Description
6008-375*	Caddy IV Camatic



Part Number	Description
1. 6008-290*	Hussey
2. 6008-291*	American 505
3. 6008-292	Irwin/American 406
4. 6008-293*	Track



Part Number	Description
6008-604 HP*	Caddy V Hussey w/Pen Holder and Binocular Post



Part Number	Description
6008-610 HP*	Caddy V Interkal w/Pen Holder and Binocular Post

Caddy I, II, IV, V & VII Custom Lines (Cont'd)

Caddy V Products



Part Number	Description	Part Number	Description
6008-630HP	Caddy V American 505- EOR Right	6008-638HP	Caddy V Hussey- EOR Upper Right
6008-632HP	Caddy V American 505- EOR Left	6008-640HP	Caddy V Hussey- EOR Upper Left
6008-634HP*	Caddy V Hussey- EOR Right	6008-642HP	Caddy V Camatic- EOR Left
6008-636HP	Caddy V Hussey- EOR Left	6008-644HP	Caddy V Camatic- EOR Right



6008-713



6008-715

Caddy VII Products / End of Row / VRC

Part Number	Description
6008-713*	Caddy VII Irwin/American- VRC Lower Right
6008-714	Caddy VII Irwin/American- VRC Lower Left
6008-715*	Caddy VII Track- EOR Lower Right
6008-716	Caddy VII Track- EOR Lower Left
6008-717*	Caddy VII Hussey- EOR Lower Right 6"
6008-718	Caddy VII Hussey- EOR Lower Left 6"
6008-719*	Caddy VII Hussey- VRC Lower Right 6"
6008-720	Caddy VII Hussey- VRC Lower Left 6"
6008-721*	Caddy VII Irwin/American- Upper Right
6008-722	Caddy VII Irwin/American- Upper Left
6008-725	Caddy VII Irwin/American- Lower Right
6008-726	Caddy VII Irwin/American- Lower Left



6008-717/719



6008-721



Caddy VII Front Row/ADA

Part Number	Description
6008-706*	Caddy VII Front Row/ADA
6008-350*	Front Row/ADA Bracket



Caddy VII Bossed

Part Number	Description
6008-705	Irwin/American 406
6008-704	Hussey
6008-711	American 505
6008-709	Track



Part Number	Description
6008-702*	Caddy VII Irwin



Part Number	Description
6008-701*	Caddy VII Track



Part Number	Description
6008-703* 6"	Caddy VII Hussey
6008-712** 5 1/2"	Caddy VII Hussey Upper Mount



Part Number	Description
6008-702*	Caddy VII American 406
6008-710**	Caddy VII American 505

*Items shown.

**Tooling required prior to production of these parts.

*Items shown.

**Tooling required prior to production of these parts.

Caddy Clamp Line



Caddy IV, V & VII Clamp Cups

Part Number	Description
1. 6008-402*	Caddy IV Clamp Cup
2. 6008-650 HP*	Caddy V Clamp w/Pen Holder and Binocular Post
3. 6008-707*	Caddy VII Clamp Cup

Typical Hardware
CCI-613 = 1½" or CCI-294 = 1¾" (2 per unit)

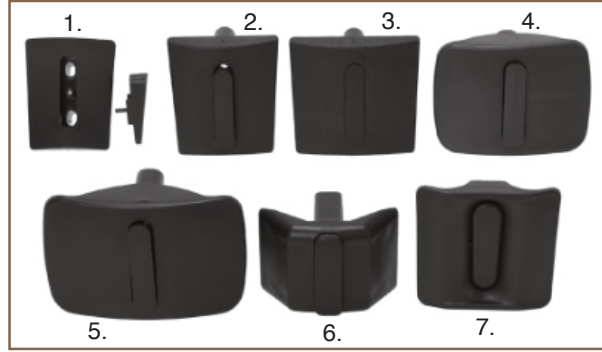

Caddy IV, V & VII Clamps

Part Number	Description	Typical Hardware
1. 6008-401*	Large Caddy Clamp	CCI-1240 (2 per unit)
2. 6008-404*	X-Large Caddy Clamp	
3. 6008-405*	XX-Large Caddy Clamp	
4. 6008-406*	Small Medallion Clamp	
5. 6008-407*	Large Medallion Clamp	
6. CCCL*	Large CC Clamp	
7. 6008-408*	Hussey Fusion Clamp	

Stadium/Arena Armrest & Arm Cap Line

Part Number	Description
1.) 6008-550* 6008-556	Irwin Stadium Armrest Irwin Small Cup Stadium Armrest
2.) 6008-551*	Irwin Stadium Arm Cap
3.) 6008-552*	American Stadium Armrest
4.) 6008-553*	American Stadium Arm Cap
5.) 6008-554* 6008-555**	Hussey Fusion Stadium Armrest Hussey Stadium Arm Cap
6.) 6008-557**	Upper Deck Armrest Cup Holder
7.) 4950* 4951	Irwin 4-U Cup Holder Irwin 4-U Spacer
8.) 6008-740*	Dual Cup Holder



Caddy Solara Cup Holder Line

Cup Holder Includes Purse Hook & Phone Holder

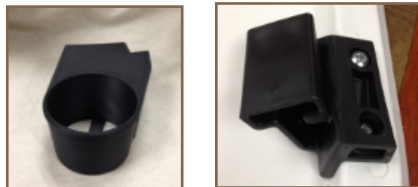

Part Number	Description	Typical Hardware
6008-560*	Caddy/Solara Rear Mount Cup Holder	CCI-1081 (2 per unit)
6008-561*	Caddy/Solara Rear Mount Bracket	
6008-562**	Caddy/Solara Armrest Cup Holder	
2" DEPTH		
6008-570L	Caddy/Integra Retractable Shallow Cup, Bracket & Dowel-2" LEFT	
6008-570R	Caddy/Integra Retractable Shallow Cup, Bracket & Dowel-2" RIGHT	
6008-570U	Caddy Retractable Shallow Cup, Bracket & Dowel-2" UNIVERSAL	
2.5" DEPTH		
6008-575L	Caddy/Integra Retractable Deep Cup, Bracket & Dowel-2.5" LEFT	
6008-575R	Caddy/Integra Retractable Deep Cup, Bracket & Dowel-2.5" RIGHT	
6008-575U	Caddy Retractable Deep Cup, Bracket & Dowel-2.5" UNIVERSAL	



Under Development

Caddy Sports Center Line

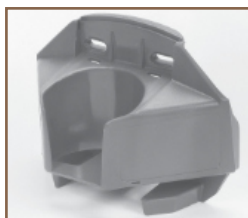

Part Number	Description
SCI	SC Interkal
SCIP*	SC Interkal w/Program Holder
Part Number	Description
1. SCC	SC Cover Interkal
2. SCCE	SC Cover HU AM Low Rise
3. SCCR	SC Cover HU AM High Rise



Part Number	Description
SC-AM	SC American Model
SC-AMP	SC American Model w/Program Holder
SC-AMHR*	SC American High Rise
SC-AMHRP	SC American High Rise w/Program Holder



Part Number	Description
SC-HU	SC Hussey
SC-HUP*	SC Hussey w/Program Holder
SC-HUHR	SC Hussey High Rise
SC-HUHRP	SC Hussey High Rise w/Program Holder

Specialty Hardware

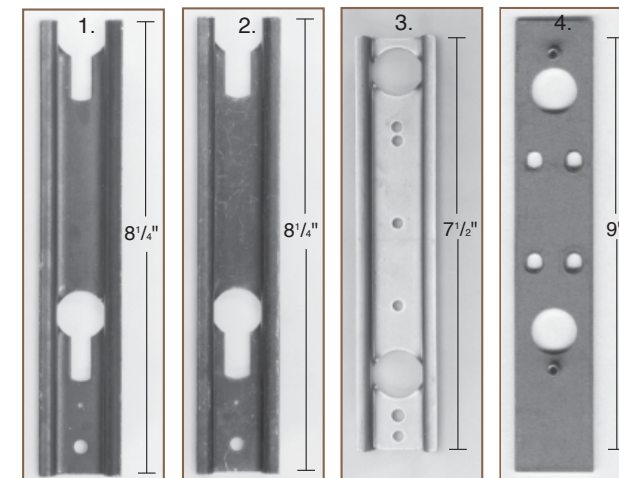

Brackets

Part Number	Description
1. MAG-AM*	American Bracket
2. MAG*	Hussey Bracket
3. MAG-IR.5R*	Irwin/Track Bracket
4. PB-1*	Attachment Bracket

Note: Retrofit attachment brackets for slide-on armrest cup holders – Slim, OF and TEL-1.

Bleacher Seating Cup Holder Line

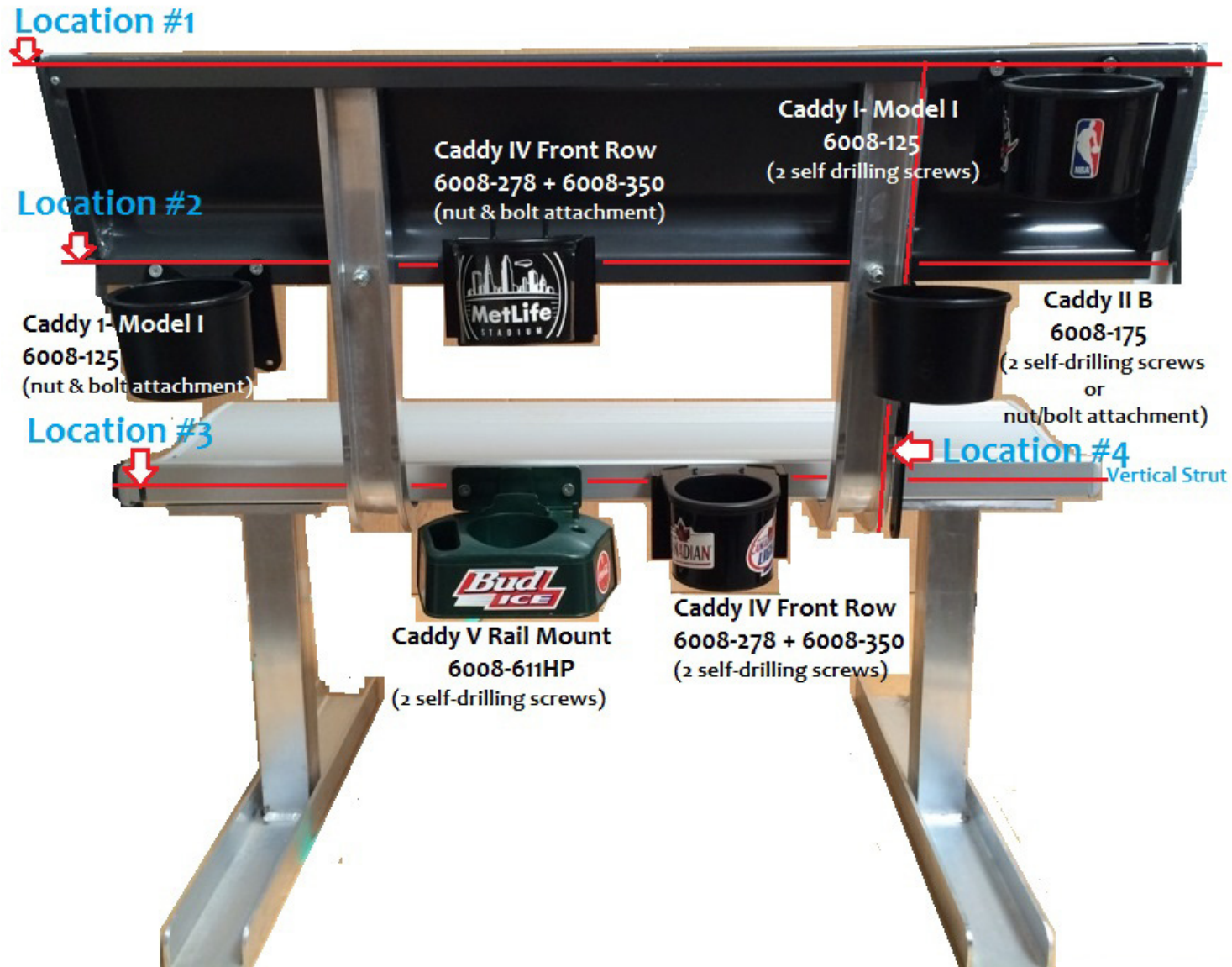

Performing Arts Line

PA Cup Holder



Part Number	Description
6008-252*	PA Cup Holder (Deep)
6008-256**	PA Cup Holder II (Shallow)

PA Cup Holder Bracket

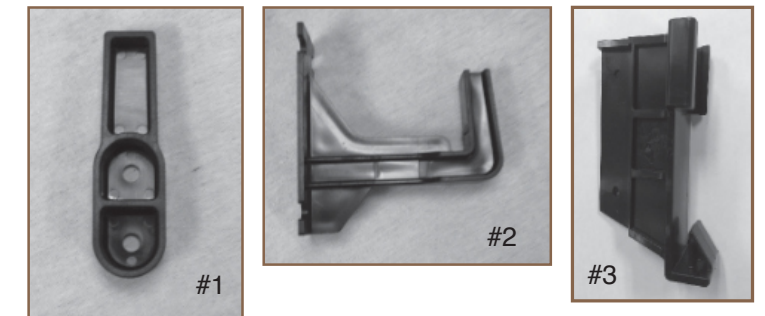

Part Number	Description
6008-253*	PA Bracket #1
6008-254*	PA Bracket #2
6008-255*	PA Bracket #3



Euro Caddy II

Part Number	Description
6008-250*	Euro Caddy II
6008-251	Snap On Cup Only



Dual Cup Holder

Part Number	Description
6008-740*	Caddy Dual Cup Holder

Cart Caddy Line

Includes Cup Holder, Phone Holder, Pen/Pencil Holder & Coupon Holder

Grocery Cup Holder – Cart Caddy



Part Number	Description
A. 6008-901*	Wire Mount
B. 6008-902*	Plastic Mount
C. 6008-903*	Coca-Cola Cart Caddy

Multiple Applications



A.

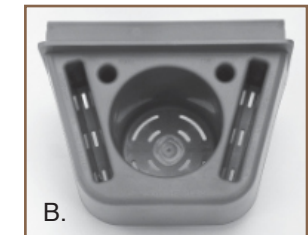

B.



C.

Typical Hardware

A. Part# 6008-901	CCI-410 (2 per unit)	CCI-411 (2 per unit)
B. Part# 6008-902	CCI-410 (4 per unit)	CCI-412 (4 per unit)
C. Part# 6008-903	CCI-410 (2 per unit)	CCI-411 (2 per unit)
	CCI-431 (1 per unit)	



CADDY RESTROOM LINE

INCLUDES CUP HOLDER, BAG HOOK AND PHONE HOLDER



Optional Ad Panel
Easily Interchangeable

Cosmetic Frame

Mounts Anywhere -
Any Color

Load Capacity
60+ Pounds

Cosmetic Frame Without Ad Panel



Includes Cup Holder, Bag Hook &
Phone Holder

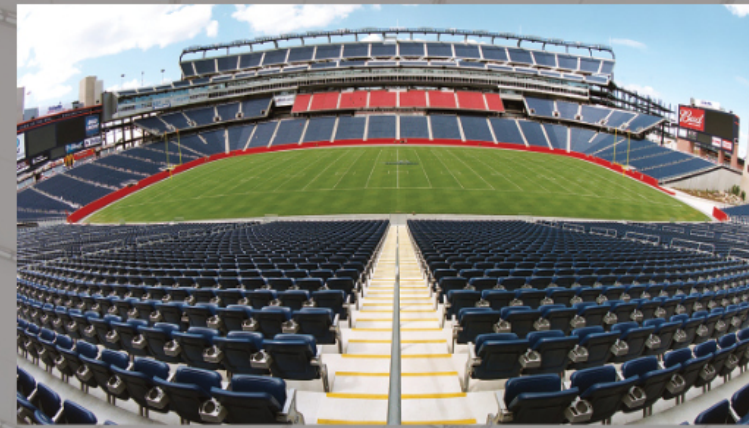

CADDY PRODUCTS®

A MOVING IMAGE TECHNOLOGIES COMPANY

Part Number	Description
6008-135	Bag/Cup/Phone Holder
6008-140	Cosmetic Frame
6008-145	Ad Panel Frame

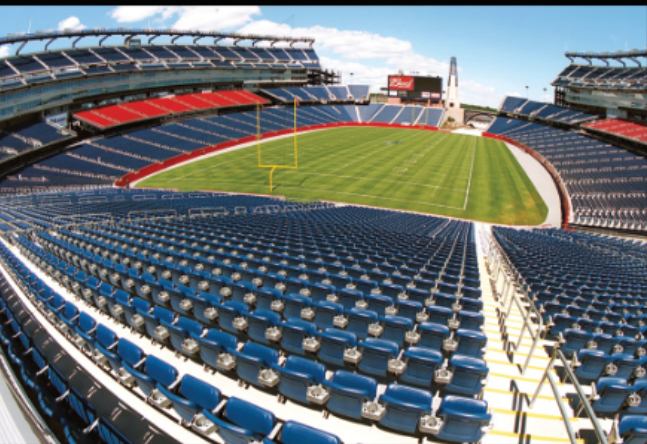

 **CADDY PRODUCTS**[®]
A MOVING IMAGE TECHNOLOGIES COMPANY

(800) 845-0591
info@caddyproducts.com
17760 Newhope St. Suite B
Fountain Valley, CA 92708

www.caddyproducts.com



MOVING IMAGE
TECHNOLOGIES

MITQ
(NYSE)